

Received: 17 Marz 2024 / Accepted: 01 May 2024 / Published online: 13 May 2024

*machine geometry,
diagonal measurement,
straightness measurement,
laser interferometer.*

Grzegorz BUDZYN^{1*},
Janusz RZEPKA^{2,3}.

THE USE OF 3-DOF LASER INTERFEROMETER FOR RAPID ESTIMATION OF CNC DRIVES SETTINGS

Although machine geometry measurements are an important part of mechanical engineering, they alone do not deliver enough information to set up or verify a CNC machine. The behaviour of the machine controller and its drive control settings usually need to be at least checked and in many situations corrected. In this article, on the basis of a developed machine error model, we show that it is sufficient to use a laser interferometer with a straightness measurement module to gather enough information in a single measurement to verify axis geometry and, at the same time, proper settings of machine servo loop gain. The results obtained during dynamic diagonal measurement can then be used to directly amend the servo settings. We prove our assumption in a series of real-world measurements.

1. INTRODUCTION

In the era of Industry 4.0 and the widespread use of artificial intelligence, the speed of operation and configuration of numerically controlled (CNC) machines has become even more important than before. Geometric, kinematic and thermal errors in such machines must be monitored and usually compensated for in order for the machines to maintain accuracy at the required level [1–3]. This means that it is usually necessary not only to check the geometry of the machine, but also to check the behavior of the drives.

There are several competing solutions on the market suitable for geometry measurements. These solutions are usually based on short-range distance detectors [4] or beam position detectors [5]. The instruments can be used in various cases [6–9] providing a set of geometric data as described, for example, in [10, 11]. Still, one of the most versatile

¹ Electronics, Wrocław University of Science and Technology, Poland

² Electronics, Photonics and Microsystems, Wrocław University of Science and Technology, Poland

³ Development, Lasertex Co. Ltd, Poland

* E-mail: grzegorz.budzyn@pwr.edu.pl

<https://doi.org/10.36897/jme/188203>

instruments for checking CNC geometry are systems based on laser interferometers [12]. For many years, interferometers have been the benchmark instrument for length measurement. Based on a basic length measurement, almost all relevant machine geometry errors, such as linear and angular positioning, straightness, perpendicularity and parallelism of axes, as well as vibration or machine acceleration/deceleration, can be measured accurately and efficiently [13]. As we presented in [14] and [15], by modifying a standard laser interferometer slightly, the amount of geometry information obtained in a single dynamic measurement can be increased.

The paper demonstrates that, based on a dedicated simulation model, it becomes possible to characterize not only the geometry, but also the settings of the main drive of CNC machines, simply by performing a dynamic laser measurement of the machine's diagonal. The proposed method produces results quickly and can be used during machine start-up, after servicing, but also during regular machine maintenance.

2. THEORY OF OPERATION

Fully analyzing the geometry of CNC machine tools in an industrial setting is a non-trivial task. Current developments in measurement techniques and equipment [16, 17] provide the end user with simpler and less time-consuming measurements. One such technique is the idea of measuring multiple possible geometry errors in a single motion - known as MultiDOF [18]. One of our previous papers [14] presented the idea of a simple modification to a standard laser interferometry system that enables such an operation. An extension of this idea by using it in diagonal measurement could also help control and tune machine drives along with checking various geometry errors.

If we treat a 3-axis CNC machine as an unconstrained rigid object, we can define 6 sources of errors for each axis of measurement (designation for the X axis in the XYZ planes of the machine) - positioning EXX , horizontal straightness EXY , vertical straightness EXZ , roll EXA , pitch EXB and yaw EXC (see Fig. 1). In addition, the planes of the machine can be at the wrong angle, so there are additional errors labeled axis perpendicularity (CXY , CYZ , CZX). Since we treat the machine as a linear object, we are able to measure and compensate for each error individually. Once the errors of all axes have been compensated for (either in the machine controller or through mechanical modifications), a final perpendicularity test can be performed. There are three main methods for this test - comparison with an angular standard, circular interpolation analysis and linear interpolation analysis [19, 20]. The first method can be classified as a direct measurement method, while the others are indirect methods. Direct measurements are usually preferred because they give mostly undistorted results that do not require complex analysis. However, in the case of perpendicularity testing, indirect methods have the advantage of providing a definitive picture of machine geometry errors. In addition, when measuring by linear interpolation, it is possible to obtain information about the behavior of machine servo systems.

According to [21], in order to compensate a machine, it is necessary to first develop an error model, then fill this model with actual data obtained from measurements, and in the final step carry out error compensation using the error model.

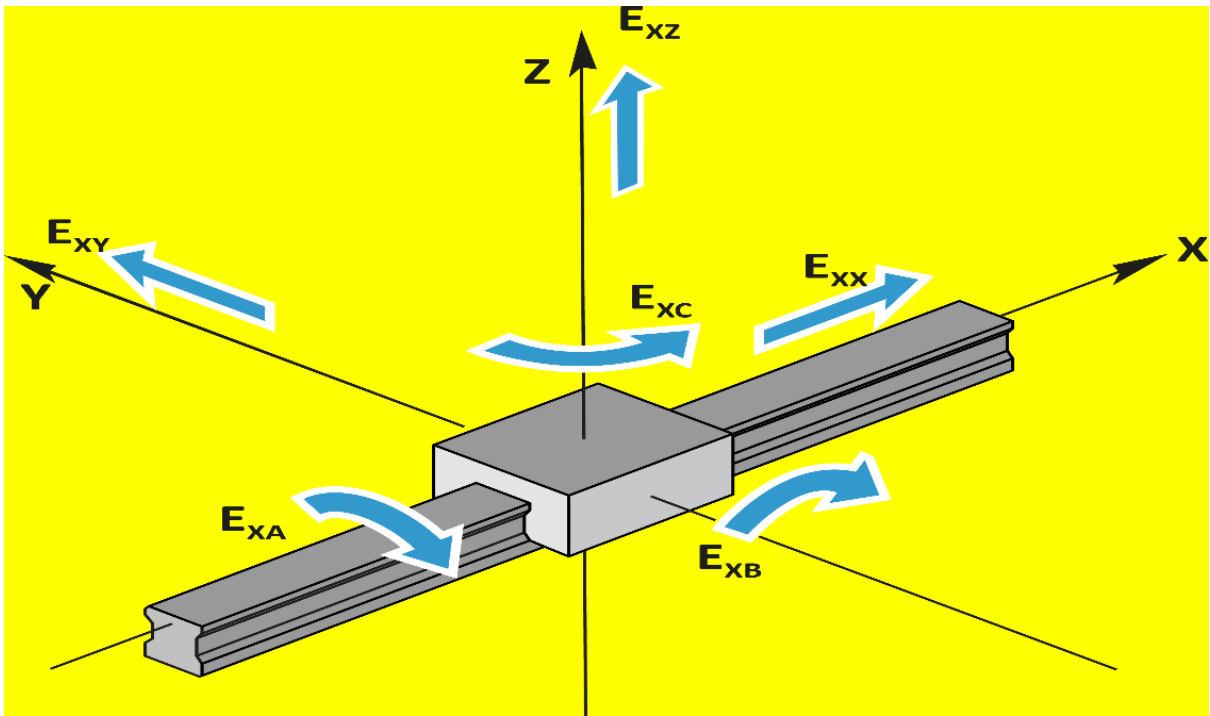

Fig. 1. Notation of geometry errors used in text. Example for axis X in an XYZ machine

There are several models useful for describing geometric errors. Among the most popular are the Screw Theory ST [22, 23], the Homogeneous Transfer Model HTM [24] and the Differential Motion Matrix DMM [25, 26]. Since we found the models too complex to accommodate measurement data from a linear laser interferometer, we decided to build our own model based on DMM. Keeping the above error designation (for axis X, see Fig. 1), we can define the components of the error vector $\varepsilon_x, \varepsilon_y, \varepsilon_z$) at each point in the machine workspace as:

$$\begin{aligned}
 \varepsilon_x(x, y, z) &= E_{XX}(x) + E_{YX}(y) + E_{ZX}(z) + (z - z_0)E_{YA}(y) + (y - y_0)E_{ZA}(z) \\
 &\quad + (y - y_0)E_{XB}(x) + (z - z_0)E_{XC}(x) \\
 \varepsilon_y(x, y, z) &= E_{YY}(y) + E_{XY}(x) + E_{ZY}(z) + (z - z_0)E_{XA}(x) + (x - x_0)E_{ZA}(z) \quad (1) \\
 &\quad + (x - x_0)E_{YB}(y) + (z - z_0)E_{YC}(y) \\
 \varepsilon_z(x, y, z) &= E_{ZZ}(z) + E_{XZ}(x) + E_{YZ}(y) + (y - y_0)E_{XA}(x) + (x - x_0)E_{YA}(y) \\
 &\quad + (x - x_0)E_{ZB}(z) + (y - y_0)E_{ZC}(z)
 \end{aligned}$$

where x_0, y_0, z_0 are ingredients of the offset vector of laser interferometer measurements against machine guide rails. The position of each rail is recognized as position 0. Using the above model has a limitation as it does not include the errors resulting from imperfect perpendicularity of axes. The improvement of the model requires introducing perpendicularity coefficients between axes, marked as CXZ, CYX and CZY . There was chosen a convention where axis X is treated as a reference when YX perpendicularity is checked, axis Y as a reference when ZY is checked and Z as a reference when XZ plane is measured. The error vector $(\varepsilon_x', \varepsilon_y', \varepsilon_z')$ of complete model can be defined as:

$$\begin{aligned}
\varepsilon'_x(x, y, z) &= E_{XX}(x) + E_{YX}(y) + E_{ZX}(z) + (z - z_0)E_{YA}(y) + (y - y_0)E_{ZA}(z) \\
&\quad + (y - y_0)E_{XB}(x) + (z - z_0)E_{XC}(x) + C_{YX}(y) \\
\varepsilon'_y(x, y, z) &= E_{YY}(y) + E_{XY}(x) + E_{ZY}(z) + (z - z_0)E_{XA}(x) + (x - x_0)E_{ZA}(z) \\
&\quad + (x - x_0)E_{YB}(y) + (z - z_0)E_{YC}(y) + C_{ZY}(z) \\
\varepsilon'_z(x, y, z) &= E_{ZZ}(z) + E_{XZ}(x) + E_{YZ}(y) + (y - y_0)E_{XA}(x) + (x - x_0)E_{YA}(y) \\
&\quad + (x - x_0)E_{ZB}(z) + (y - y_0)E_{ZC}(z) + C_{XZ}(x)
\end{aligned} \tag{2}$$

The error vector can be used to calculate the errors of the diagonal. For the clarity of presentation in the paper we focus on planar diagonals in XY, YZ and ZX planes. It is possible to extend the analysis to volumetric diagonals XYZ as well.

For the case of planar diagonals there can be defined errors along the diagonals (ε'_{xyh} , ε'_{yzh} , ε'_{zxh}) and perpendicular to the diagonals (ε'_{xyv} , ε'_{yzv} , ε'_{zxv}) at planes at x_0 , y_0 , z_0 from machine base as:

$$\begin{aligned}
\varepsilon'_{xyh}(x, y, z_0) &= \cos(\alpha) * \varepsilon'_x(x, y, z_0) + \sin(\alpha) * \varepsilon'_y(x, y, z_0) \\
\varepsilon'_{xyv}(x, y, z_0) &= \sin(\alpha) * \varepsilon'_x(x, y, z_0) - \cos(\alpha) * \varepsilon'_y(x, y, z_0) \\
\varepsilon'_{yzh}(x_0, y, z) &= \cos(\beta) * \varepsilon'_y(x_0, y, z) + \sin(\beta) * \varepsilon'_z(x_0, y, z) \\
\varepsilon'_{yzv}(x_0, y, z) &= \sin(\beta) * \varepsilon'_y(x_0, y, z) - \cos(\beta) * \varepsilon'_z(x_0, y, z) \\
\varepsilon'_{zxh}(x, y_0, z) &= \cos(\gamma) * \varepsilon'_z(x, y_0, z) + \sin(\gamma) * \varepsilon'_x(x, y_0, z) \\
\varepsilon'_{zxv}(x, y_0, z) &= \sin(\gamma) * \varepsilon'_z(x, y_0, z) - \cos(\gamma) * \varepsilon'_x(x, y_0, z)
\end{aligned} \tag{3}$$

where α , β , γ are the angles between diagonal and the main axis of the plane, e.g. X for XY plane, Y for YZ plane and Z for ZX plane. Graphical explanation of the calculation of formula (3) for XY plane is given in Fig. 2.

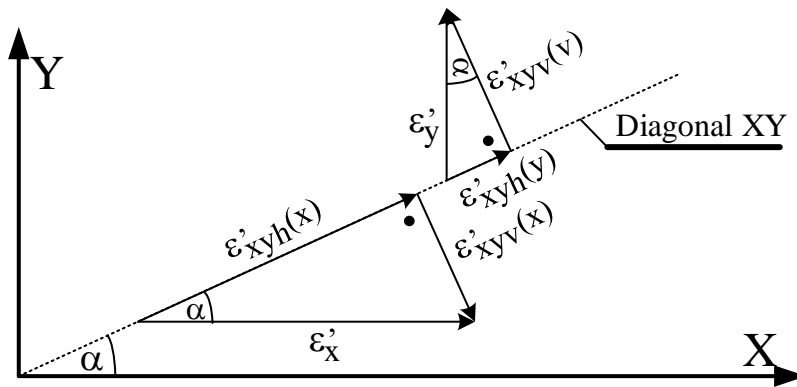

Fig. 2. Calculation of errors along and perpendicular to the diagonal for XY plane

In order to compare simulations with a 3-DOF laser interferometer measurements it is necessary to eliminate trend and offset from errors perpendicular to diagonals ε'_{xyv} , ε'_{yzv} , ε'_{zxv} . This is not necessary for errors along diagonal. Trend and offset compensation can be noted as:

$$\begin{aligned}
 \varepsilon''_{xyv}(x, y, z_0) &= \varepsilon'_{xyv}(x, y, z_0) - \varepsilon'_{xyv}(x_0, y_0, z_0) - \left(\frac{\varepsilon'_{xyv}(x_f, y_f, z_0) - \varepsilon'_{xyv}(x_0, y_0, z_0)}{x_f - x_0} \right) * x \\
 \varepsilon''_{yzv}(x_0, y, z) &= \varepsilon'_{yzv}(x_0, y, z) - \varepsilon'_{yzv}(x_0, y_0, z_0) - \left(\frac{\varepsilon'_{yzv}(x_0, y_f, z_f) - \varepsilon'_{yzv}(x_0, y_0, z_0)}{y_f - y_0} \right) * y \quad (4) \\
 \varepsilon''_{zxv}(x, y_0, z) &= \varepsilon'_{zxv}(x, y_0, z) - \varepsilon'_{zxv}(x_0, y_0, z_0) - \left(\frac{\varepsilon'_{zxv}(x_f, y_0, z_f) - \varepsilon'_{zxv}(x_0, y_0, z_0)}{z_f - z_0} \right) * z
 \end{aligned}$$

3. SIMULATIONS

In order to see the influence of singular errors on the overall machine error we performed a series of simulations. For example, in the case of the XY plane and the positioning errors of both the X and Y axes, as shown in Fig. 3, we expect diagonal errors along and perpendicular to the diagonal, as shown in Fig. 4. Diagonal errors vary considerably and therefore should be analyzed together with accessible single errors during the actual measurement.

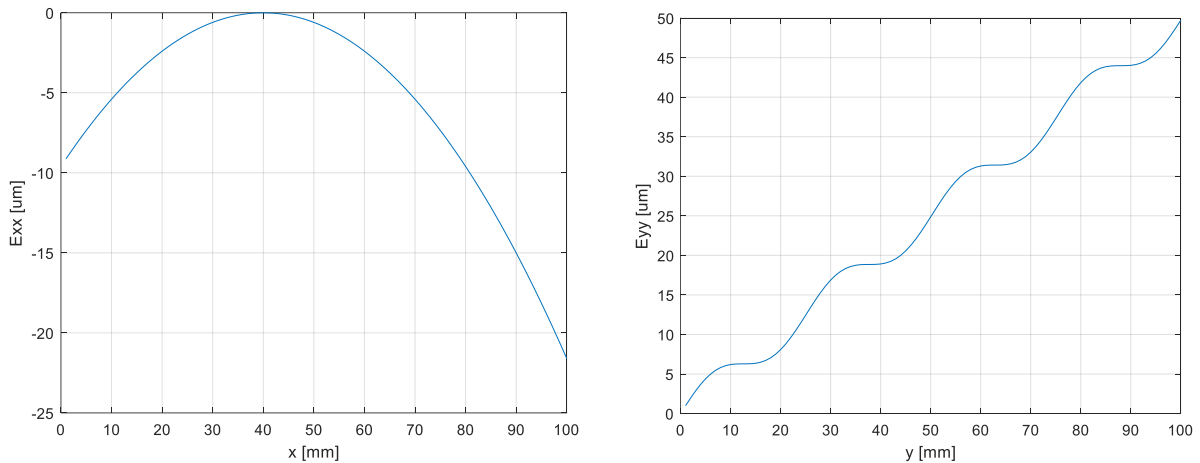

Fig. 3. Position errors E_{xx} and E_{yy} used in simulation

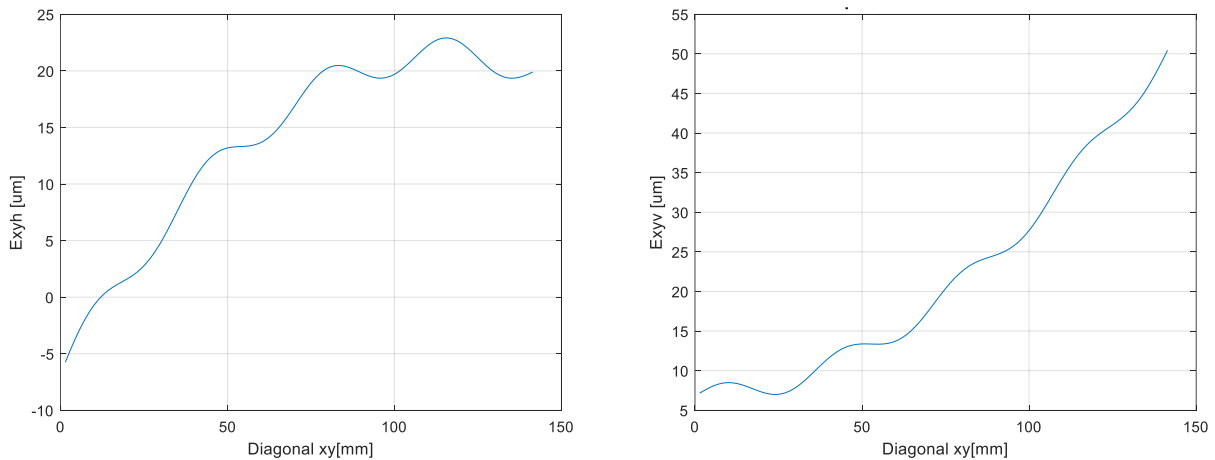

Fig. 4. Diagonal errors E_{xyh} and E_{xyv} for the case including multiple single errors and reverse movement

The more single errors are added, the more complex the diagonal error. Examples of diagonal errors involving an expanded set of single errors (EXX , EYY , EXY , EYX , EXB , EXC , EYB and EYC) are shown in Fig. 5. In addition, a simulation was carried out for the case mimicking the forward and reverse movement of the machine. For the perpendicular error, the trend elimination method was applied according to equation (4).

In almost all cases, trend elimination is necessary for direct comparison with laser interferometer results. On the contrary, the offset should be eliminated carefully. Its automatic compensation means a loss of information. From a practical point of view, an interesting case, when an accurate analysis of offsets is required, is the measurement of the machine diagonal in two directions (i.e., away from the laser assembly and toward the laser assembly).

According to our model, a shift between forward and backward errors perpendicular to the diagonal is only possible if there is a shift between the forward and backward results of at least one single error (see Fig. 6). Viewed from another perspective, if a shift is observed on the perpendicular diagonal error, but this shift is not satisfied in the individual errors of the machine, it means that this machine's servo settings are incorrect. Such a case is important from a practical point of view and will be shown in the next paragraph.

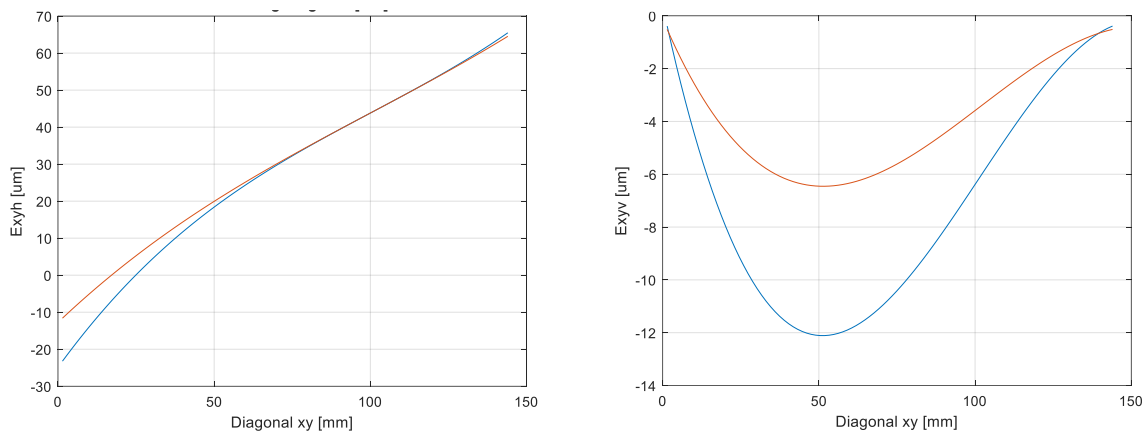

Fig. 5. Diagonal errors $Exyh$ and $Exyv$ for the case including multiple single errors (bleu line) and reverse movement (red line)

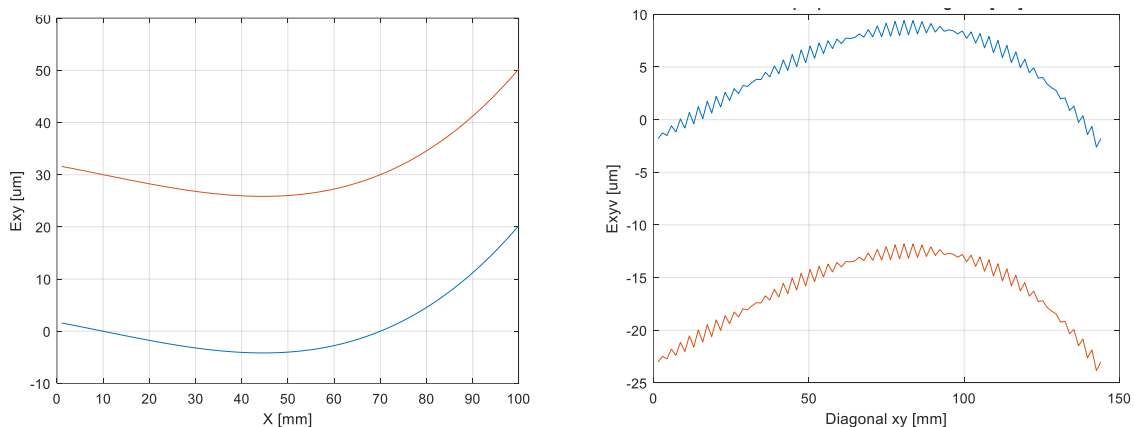

Fig. 6. Influence of offset in single errors on the offset of diagonal error $Exyv$ for the case including forward (bleu line) and reverse movement (red line)

According to the model shown above, the diagonal measurement can be used to definitively check the accuracy of the machine. Diagonal errors give a complex picture of machine problems. It can be concluded that if the values of the diagonal error vector are within the selected limits, then the quality of the machine geometry is proper. Another conclusion from the simulation is that if none of the individual machine errors change with the machine feed, then none of the diagonal error components change with the machine feed.

4. TEST MEASUREMENTS

In order to verify the applicability of diagonal testing with a 3DOF laser interferometer, a number of tests were carried out on various CNC machines. This paper presents measurements made on a 3-axis CNC machine tool with a Fanuc 0i (MUT) controller. The working range of the analyzed machine was $550 \text{ mm} \times 400 \text{ mm} \times 500 \text{ mm}$ in X , Y and Z axes, respectively.

For the reasons mentioned in the previous paragraph, the diagonal measurement should be performed as a final measurement during geometry testing. Simplifying the case to a single-plane measurement, the instrument layout is shown in Fig. 7. Layout A is used to check the individual errors of each axis under test (e.g., E_{XX} , E_{XY} , E_{XZ} , E_{XB} and E_{XC} for the X axis in the XY plane).

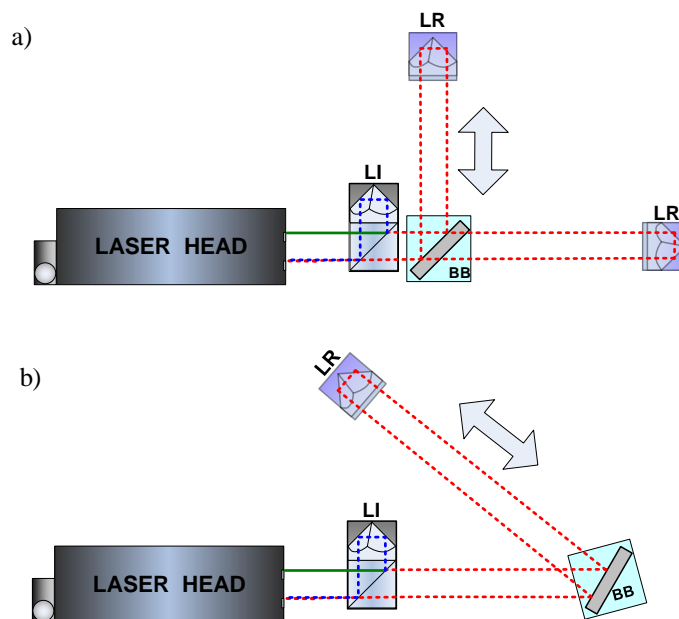

Fig. 7. Measurement setup used in testing diagonal errors. Configuration A used to measure and nullify positioning errors of the machine (E_{XX} and E_{YY}). Configuration B used to test diagonal error. BB–Beam bender, LR–linear reflector, LI–linear interferometer

The results can be used to improve motion quality by modifying the machine hardware (typically E_{XB} and E_{XC}) or modifying the machine controller (typically E_{XX} , E_{XY} and E_{XZ}). The second axis can be measured after modifying the initial optical configuration by repositioning the laser head along the path or adding a BB beam deflecting element along the path. The second solution is much faster and

simpler under real-world conditions, although the BB can affect the final results. For the instrument used, the impact is negligible, as the measurement process usually takes only a few minutes. The BB element can also be used when setting up diagonal tests. Another option is to place the laser unit directly on the diagonal, but this is usually a more time-consuming option.

The layout of the components on the machine is shown in Fig. 8. For brevity, only the configuration in Fig. 7b is shown. First, the X and Y axes were measured in 3D mode, and then the E_{XX} and E_{YY} errors were compensated in the controller options. After compensation, both positioning errors decreased below 5 μm . The straightness errors created during the positioning calibration in the XY plane are shown in Fig. 9a and 9b.

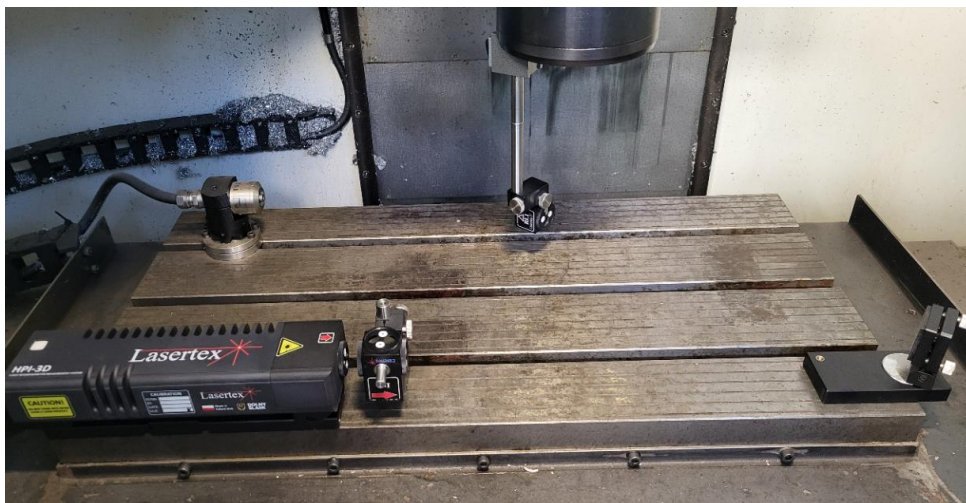

Fig. 8. Placement of device components on the tested machine

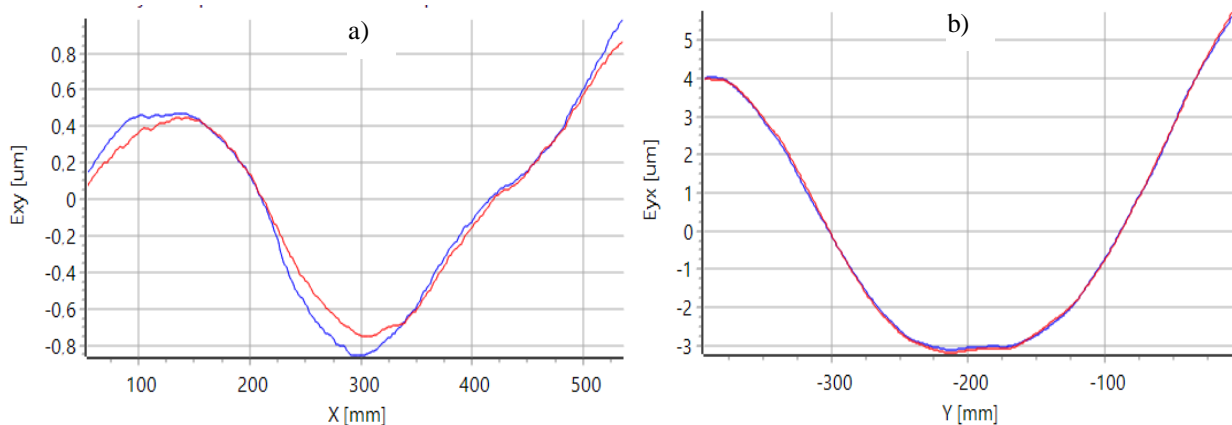

Fig. 9. Straightness errors E_{XY} and E_{YX} on tested machine after trend elimination. Blue line – measurements from the laser, red line – measurements towards the laser. Measurements performed in circuit shown in Fig. 7a

The measurements shown in Fig 9 were taken in two directions. The blue line in both diagrams shows situations where the LR component moves away from the LI component, while the red lines represent the opposite situation. According to the model described in the previous section, the two lines should overlap. The differences in this case may be due to several factors. Among them, the most important are the non-rigidity of the machine's design,

the wear of some of the machine's drive components (such as bearings), and incorrect settings of the controller.

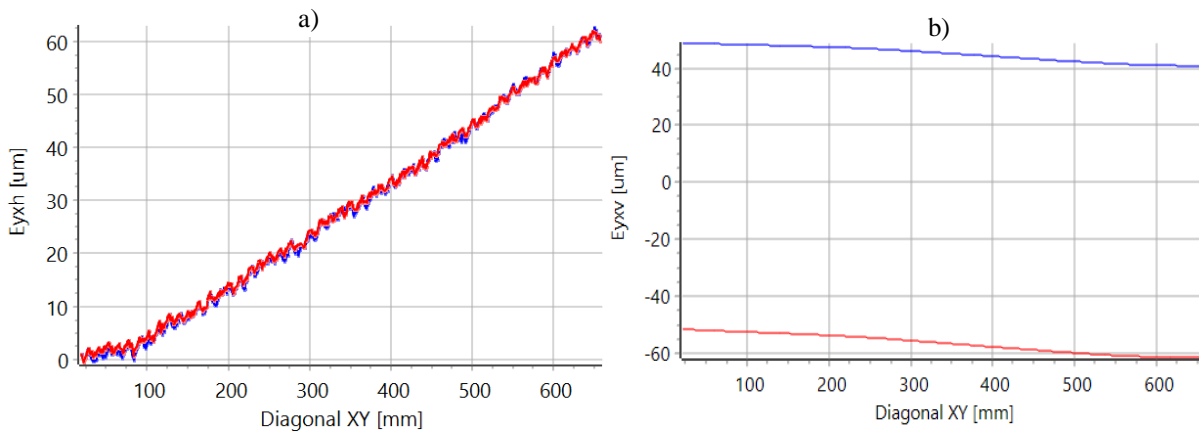

Fig. 10. Diagonal error measurements of MUT, a) error along diagonal, b) error perpendicular to diagonal.

The circuit was then reconfigured to the configuration shown in Fig. 7b. The errors obtained along the diagonal (horizontal and vertical) are shown in Fig. 10. Considering the EXX and EYY error compensation in the machine controller, the most likely cause of the almost linear $EXYH$ error would be the perpendicularity error between the X and Y axes $CXY \cong 0.1$ mm/m. For the case of $EXYV$ error, a large offset was observed between the two directions of motion. Since no significant offset was observed for EXY and EYX errors, thus the problem was either the result of wear on machine components or a problem with the machine's servo settings. To determine the cause, the diagonal measurements were repeated at a different feed rate. The reason for this is that the first error (i.e. machine wear) is feed-independent down to the machine stiffness, while the second is strongly feed-dependent.

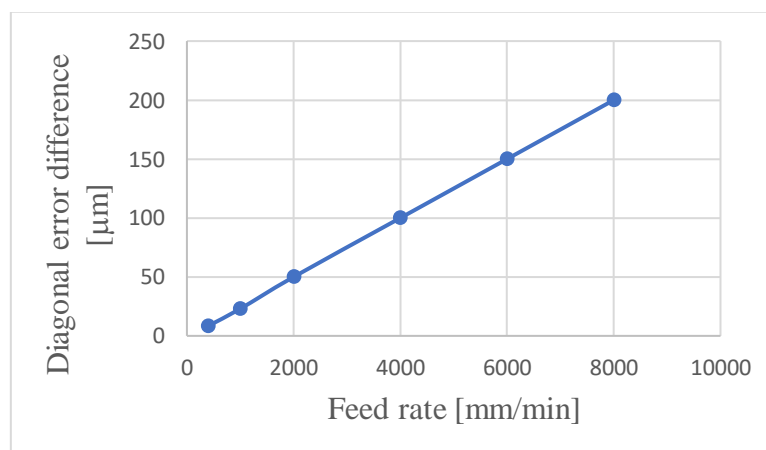

Fig. 11. Dependence of diagonal error $EXYV$ offset on machine feed rate as measured on MUT.

A comparison of the results obtained at different feed rates (Fig. 11) showed a linear relationship - the higher was the feed rate of the machine, the greater was the offset between

the errors of the diagonal perpendicular to the motion recorded in the two directions. Such a behavior is expected as the following error of major CNC controllers is proportional to the machine feed rate and inversely proportional to the value of loop gain parameter k_v (see [27] or [28]). Scale of the diagonal error offset depends on loop gain difference between tested axes.

The reduction of this offset requires modification of loop gain parameters of one of the axes. In most controllers it is enough to level loop gains in both axes though. The correction has to be done with care, to avoid problems mentioned for example in [29] and [30]. For the MUT there was observed an imbalance in controller settings in Loop Gain parameter (1825 in Fanuc 0i) between axes X and Y . In axis X this parameter was set to 2000 while in axis Y it was set to 4000. After modification of both parameters to 4000, the offset in $EXYV$ error was reduced to single micrometers as shown in Fig. 12.

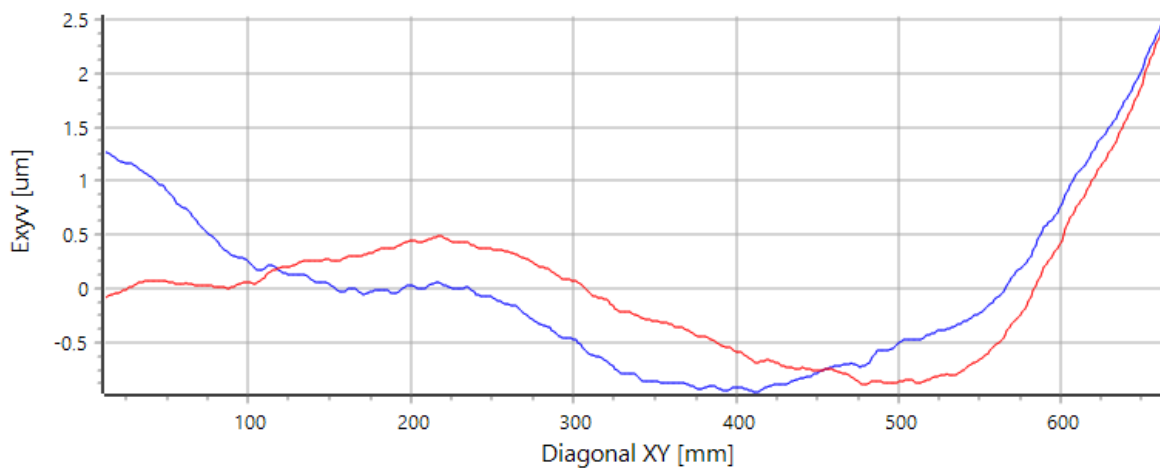

Fig. 12. Diagonal error of MUT perpendicular to diagonal after controller settings correction.

5. CONCLUSION

As demonstrated in the article, dynamic measurements of a machine's diagonal provide additional important information about the machine's geometry. With such a measurement, made with a 3-DOF laser interferometer, most geometry errors can be easily found, traced and compensated for. Based on our model, we proved that also typical controller errors can be easily compensated without additional time requirement. The presented method is all the more advantageous the larger the machine, since the measurement time itself hardly scales with the length of the axis. Also, comparing to methods based on circular measurements, laser interferometer based diagonal measurements delivers straightforward information about geometry or controller errors in comparable or shorter time.

Obtained results are in agreement with the theoretical model presented in the article. The model is constructed in such a way that it is possible to directly use the measurement data obtained from the modified 3-DOF laser. This can be very helpful especially in situations where an incomplete set of measurement data is available when compensating for machine geometry.

CONFLICT OF INTEREST

The authors declare that there is no competing financial interest or personal relationship that could have appeared to influence the work reported in this paper.

ACKNOWLEDGEMENT

The authors express their thanks to NCBiR (The National Centre for Research and Development <https://www.gov.pl/web/ncbr-en>) for supporting the research on intelligent machine tools, Project number POIR.04.01.04-00-0002/20-00.

REFERENCES

- [1] TUREK P., MODRZYCKI W., JEDRZEJEWSKI J., 2010, *Analysis of Machine Tool Error Compensation Methods*, Inżynieria Maszyn, 13, 1/2, 130–149 (in Polish).
- [2] JEDRZEJEWSKI J., MODRZYCKI W., 2007, *Compensation of Thermal Displacements of High-Speed Precision Machine Tools*, Journal of Machine Engineering, 7/1, 108–114.
- [3] TUREK P., JEDRZEJEWSKI J., MODRZYCKI W., 2010, *Methods of Machine Tool Error Compensation*, Journal of Machine Engineering, 10/4, 5–25.
- [4] Renishaw, *BallBar QC20-W, Instruction Manual*, <https://www.renishaw.com/en/qc20-w-ballbar-system-11075>, (accessed on 15 May 2020).
- [5] StatusPro, *ProLine 200, Instruction Manual*, Available online: https://www.statuspro.com/machine_tool_alignment/proline_200/, (accessed on 15 May 2020).
- [6] JIANG X., WANG L., LIU C., 2019, *Geometric Accuracy Evaluation During Coordinated Motion of Rotary Axes of a Five-Axis Machine Tool*, Measurement: Journal of the International Measurement Confederation, 146, 403–410.
- [7] XIANG S., LI H., DENG M., et al., 2018, *Geometric Error Identification and Compensation for Non-Orthogonal Five-Axis Machine Tools*, Int. J. Adv. Manuf. Technol., 96, 2915–2929.
- [8] ISO 230-2, 2014, *Test Code for Machine Tools, Part 2, Determination of Accuracy and Repeatability of Positioning of Numerically Controlled Axes*.
- [9] MAREK T., BERTHOLD J., HOLUB M., 2018, *A Quasi-Online Geometric Errors Compensation Method on CNC Machine Tool*, 18th Int. Conf. on Mechatronics – Mechatronika, Brno; Czech Republic; 5–7 December 2018.
- [10] MONTAVON B., DAHLEM P., et al., 2018, *Modelling Machine Tools using Structure Integrated Sensors for Fast Calibration*, Journal of Manufacturing and Material Process, 2/1, 14, <https://doi.org/10.3390/jmmp2010014>.
- [11] KUANG C., et al., 2005, *A Four-Degree-of-Freedom Laser Measurement System (FDMS) Using a Single-Mode fiber-Coupled Laser Module*, Sensors and Actuators A: Physical, 125, 100–108.
- [12] RZEPKA J., BUDZYN G., 2003, *Laser Measurement System for Machine Tools*, Optical Metrology 2003, 30 May, Proc. SPIE 5144, Optical Measurement Systems for Industrial Inspection III.
- [13] HPI-3D, *Instruction Manual*, 2020, www.lasertex.eu.
- [14] BUDZYN G., RZEPKA J., KALUZA P., 2021, *Laser Interferometer Based Instrument for 3D Dynamic Measurements of CNC Machines Geometry*, Optics and Lasers in Engineering, 142, <https://doi.org/10.1016/j.optlaseng.2021.106594>.
- [15] BUDZYN G., RZEPKA J., KALUZA P., 2018, *Comparison of Static and Dynamic Laser Based Positioning Methods for Characterization of CNC Machines*, Journal of Machine Engineering, 18/4, 39–46.
- [16] Renishaw, 2016, *XL-80 Laser Measurement System*.
- [17] DAHLEM P., MONTAVON B., PETEREK M., SCHMITT R.H., 2018, *Enhancing Laser Step Diagonal Measurement by Multiple Sensors for Fast Machine Tool Calibration*, Journal of Machine Engineering, 18/2, 64–73.
- [18] Renishaw, 2019, *XM-60 and XM-600 Multi-Axis Calibrator*.
- [19] ISO 230-6:2002, *Test Code for Machine Tools, Part 6, Determination of Positioning Accuracy on Body and Face Diagonals (Diagonal Displacement Tests)*, ISO, Geneva.

- [20] SVOBODA O., 2006, *Testing the Diagonal Measuring Technique*, *Precision Engineering*, 30, 132–144.
- [21] HSU Y., WANG S., 2007, *A New Compensation Method for Geometry Errors of Five-Axis Machine Tools*, *International Journal of Machine Tools and Manufacture*, 47/2, 352–60.
- [22] MURRAY R., LI Z., SASTRY S., 1994, *A Mathematical Introduction to Robotic Manipulation*, Boca Raton: CRC Press.
- [23] DIMOVSKI I., TROMPESKA M., SAMAK S., et.al., 2018, *Algorithmic Approach to Geometric Solution of Generalized Paden-Kahan Subproblem and its Extension*, *International Journal of Advanced Robotic System*, 15/1, 1–11.
- [24] FAN K., YANG J., YANG L., 2015, *Unified Error Model Based Spatial Error Compensation for Four Types of CNC Machining Center: Part I-Singular Function Based Unified Error Model*, *Mechanical Systems and Signal Processing*, 60/61, 656–67.
- [25] YANG JX., DING H., 2016, *A New Position Independent Geometric Errors Identification Model of Five-Axis Serial Machine Tools Based on Differential Motion Matrices*, *Journal of Machine Tools and Manufacture*, 104, 68–77.
- [26] FU G., FU J., XU Y., et al., 2015, *Accuracy Enhancement of Five-Axis Machine Tool Based on Differential Motion Matrix: Geometric Error Modeling, Identification and Compensation*, *Journal of Machine Tools and Manufacture*, 89, 170–181.
- [27] HEIDENHAIN, iTNC530, 2002, *Technical Manual*, February.
- [28] SIEMENS, Sinumerik 840Di sl, *Commissioning Manual*, 05/2008.
- [29] GRAU J., SULITKA M., SOUCEK P., 2019, *Influence of Linear Feed Drive Controller Setting in CNC Turning Lathe on the Stability of Machining*, *Journal of Machine Engineering*, 19/2, 18–31.
- [30] KWON H.D., BURDEKIN M., 1998, *Adjustment of CNC Machine Tool Controller Setting Values by an Experimental Method*, *Journal of Machine Tools and Manufacture*, 38, 1045–1065.